



AMP

| Junior Power Timer, LEAVYSEAL, RAST 5 IDC Connectors, RAST 5D, Timer Connector System

TE Internal #: 1-1579007-6

Insertion & Extraction Tools, Contact Extraction, Contact-to-Wire, Timer Connector System

[View on TE.com >](#)

Application Tooling > Insertion & Extraction Tools



Insertion & Extraction Tool Type: **Contact Extraction**

Insertion & Extraction Tool Application: **Contact-to-Wire**

**Features**

**Product Type Features**

Insertion & Extraction Tool Type	Contact Extraction
Insertion & Extraction Tool Application	Contact-to-Wire

**Product Compliance**

[For compliance documentation, visit the product page on TE.com>](#)

EU RoHS Directive 2011/65/EU	Not Compliant
EU ELV Directive 2000/53/EC	Out of Scope
China RoHS 2 Directive MIIT Order No 32, 2016	Restricted Materials Above Threshold
EU REACH Regulation (EC) No. 1907/2006	Current ECHA Candidate List: JUNE 2022 (224) Candidate List Declared Against: JUNE 2022 (224) SVHC > Threshold: Pb (1.28% in Component Part) <small>Article Safe Usage Statements: Do not eat, drink or smoke when using this product. Wash thoroughly after handling. Recycle if possible and dispose of the article by following all applicable governmental regulations relevant to your geographic location.</small>
Halogen Content	Low Halogen - Br, Cl, F, I < 900 ppm per homogenous material. Also BFR/CFR/PVC Free
Solder Process Capability	Not applicable for solder process capability

Product Compliance Disclaimer

This information is provided based on reasonable inquiry of our suppliers and represents our current actual knowledge based on the information they provided. This information is subject to change. The part numbers that TE has identified as

EU RoHS compliant have a maximum concentration of 0.1% by weight in homogenous materials for lead, hexavalent chromium, mercury, PBB, PBDE, DBP, BBP, DEHP, DIBP, and 0.01% for cadmium, or qualify for an exemption to these limits as defined in the Annexes of Directive 2011/65/EU (RoHS2). Finished electrical and electronic equipment products will be CE marked as required by Directive 2011/65/EU. Components may not be CE marked. Additionally, the part numbers that TE has identified as EU ELV compliant have a maximum concentration of 0.1% by weight in homogenous materials for lead, hexavalent chromium, and mercury, and 0.01% for cadmium, or qualify for an exemption to these limits as defined in the Annexes of Directive 2000/53/EC (ELV). Regarding the REACH Regulation, the information TE provides on SVHC in articles for this part number is based on the latest European Chemicals Agency (ECHA) 'Guidance on requirements for substances in articles' posted at this URL: <https://echa.europa.eu/guidance-documents/guidance-on-reach>

## Compatible Parts



TE Part # CAT-L489-CH8172  
LEAVYSEAL HOUSINGS

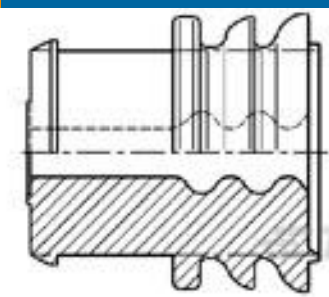

TE Part # 963243-1  
EINZELDRAHTDICHTUNG



TE Part # 964203-5  
STD PW TIMER CONTACT



TE Part # 964204-1  
STD-POW-TIM KONTAKT



TE Part # 963244-1  
EINZELDRAHTDICHTUNG



TE Part # 963245-1  
EINZELLEIT-DICHTUNG



TE Part # 964203-1  
STD PW TIMER CONTACT



TE Part # 928890-1  
TAB



TE Part # CAT-T4827-T273  
TIMER, RECEPTACLE AND TAB



TE Part # 185001-6  
4P TAB JPT HOUSING



TE Part # CAT-M4595-CH8172  
MCON, CONNECTOR HOUSING



TE Part # 6-962916-7  
FLACHSTECKER2,8X0,8



TE Part # 929930-3  
JUN-POW-TIM CONTACT L/P



TE Part # 927838-2  
SPT REC 6.3 Contact SRC Sn (LP)



TE Part # 1-968050-1  
SPECIAL TERMINAL 11-10 AWG PTPB



TE Part # 1747251-1  
MT 6POS PLUG HSG



## Also in the Series | Junior Power Timer

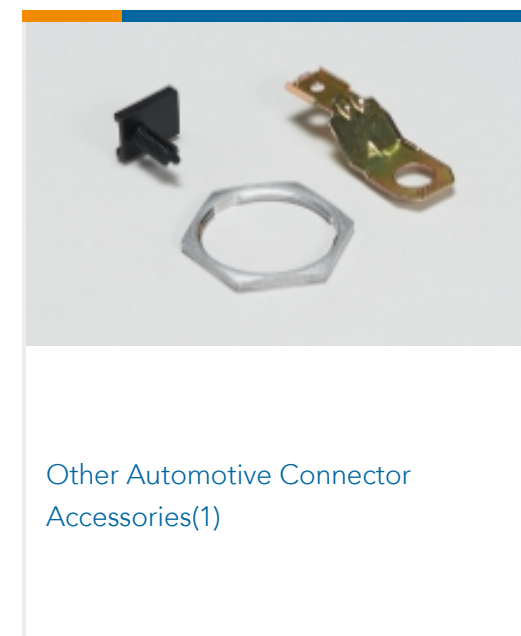
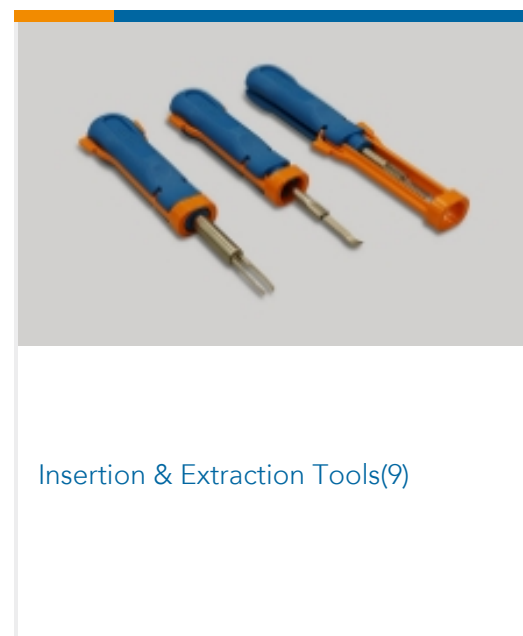
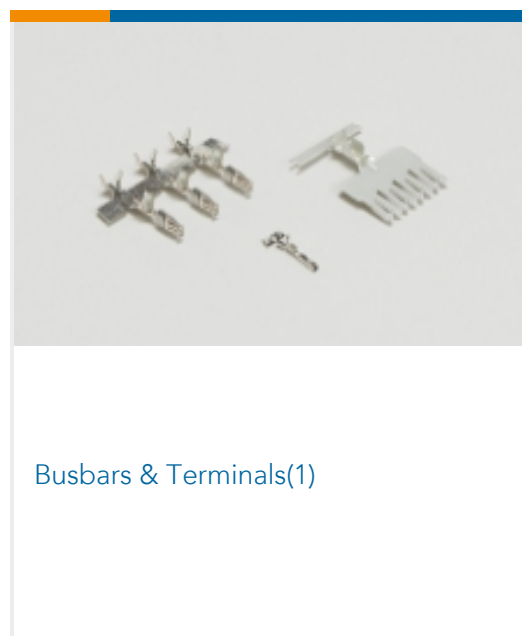
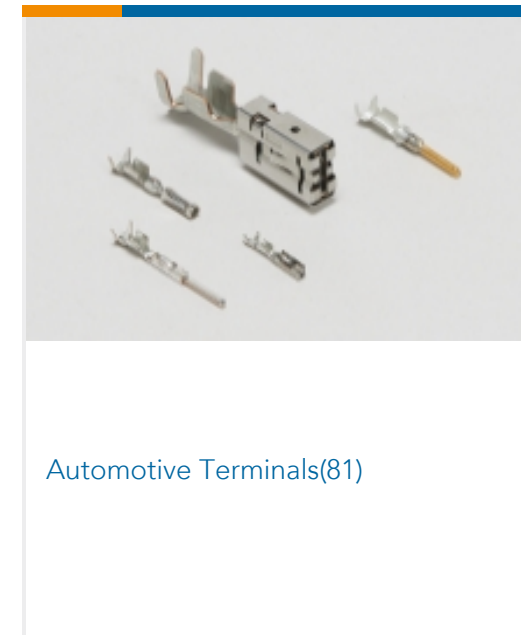
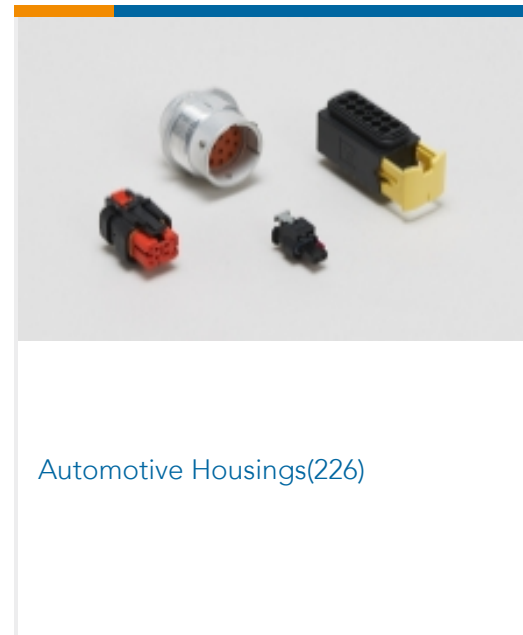

## Also in the Series | LEAVYSEAL



Automotive Connector Caps & Covers (16)

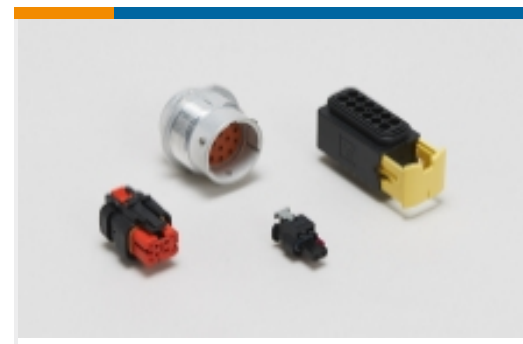

Automotive Housings(64)

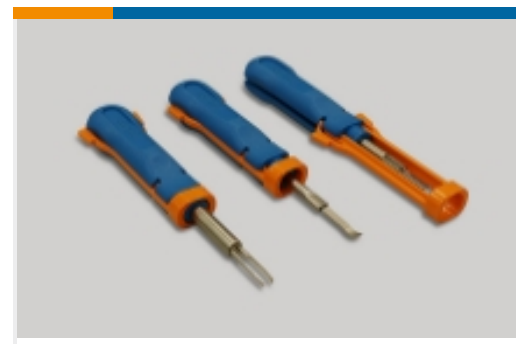

Insertion & Extraction Tools(5)



Other Automotive Connector Accessories(15)

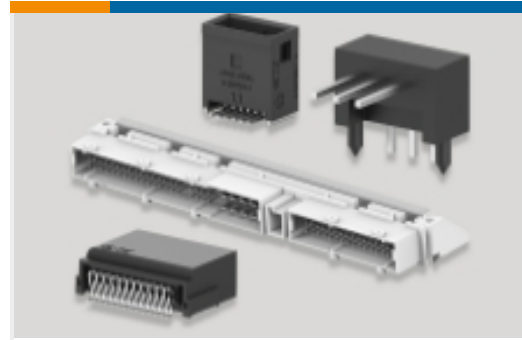

PCB Headers & Receptacles(13)

## Also in the Series | RAST 5 IDC Connectors



Automotive Terminals(8)



Connector Contacts(12)



Crimp Terminal Housings(41)



Insertion & Extraction Tools(1)

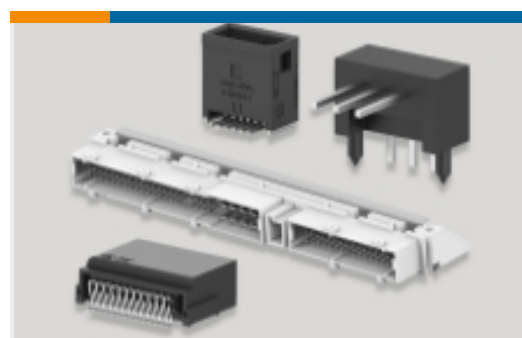

PCB Headers & Receptacles(424)



Rectangular Connector Housings(1)

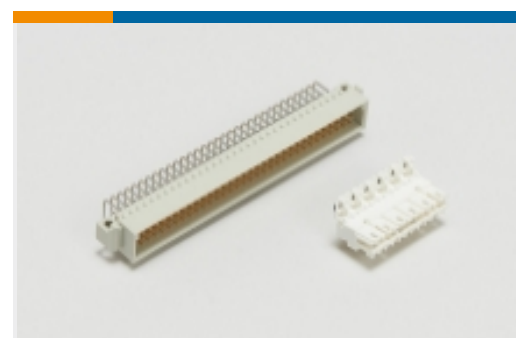

Standard Edge Connectors(47)



Standard Rectangular Connectors(112)

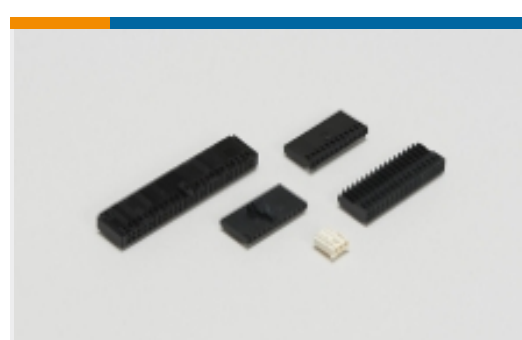

Wire-to-Board Connector Assemblies & Housings(213)



Wire-to-Board Connector Contacts(2)

## Also in the Series | RAST 5D



Automotive Terminals(5)

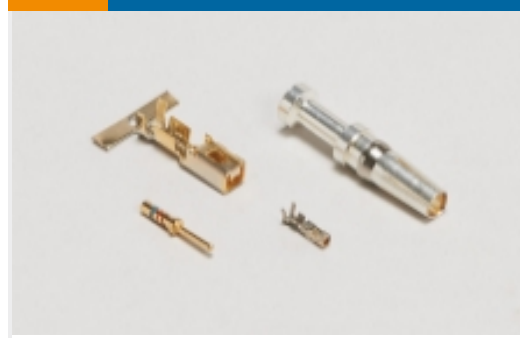

Connector Contacts(10)



Insertion & Extraction Tools(1)

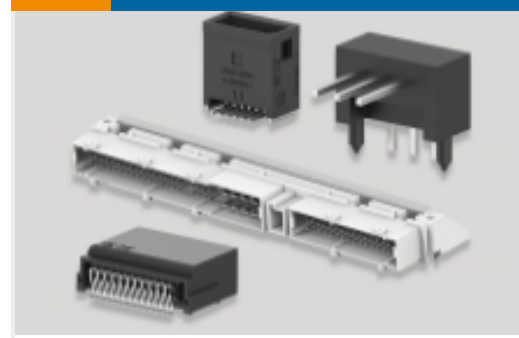

PCB Headers & Receptacles(86)



Wire-to-Board Connector Assemblies & Housings(93)

## Also in the Series | Timer Connector System



Automotive Connector Caps & Covers(11)

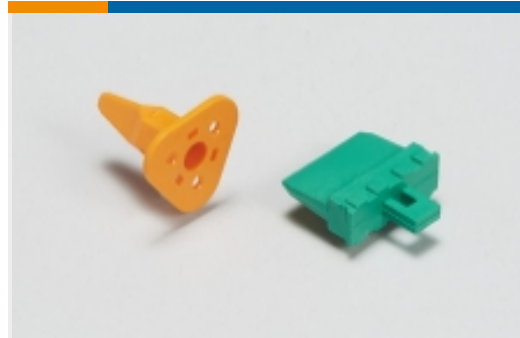

Automotive Connector Locks & Position Assurance(16)



Automotive Housings(218)



Automotive Seals & Cavity Plugs(31)



Automotive Terminals(130)



Crimp Terminal Housings(13)



Insertion & Extraction Tools(20)



Other Automotive Connector Accessories(1)

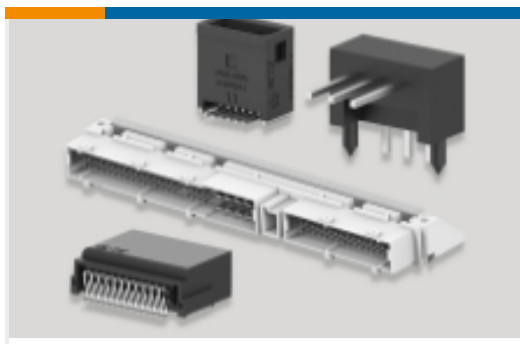

PCB Headers & Receptacles(78)



Quick Disconnects(4)

## Documents

### Product Drawings

[EXTRACTION TOOL](#)

English

---

### Datasheets & Catalog Pages

[HDSCS Catalog](#)

English

[CONNECTOR SELECTOR](#)

English

---

### Product Specifications

[Application Specification](#)

English

---

### Instruction Sheets

[Instruction Sheet \(U.S.\)](#)

English